

Name: _____

6TH GRADE INTO 7TH SUMMER REVIEW: MATH

The following packet will help you prepare for 7th grade math by reviewing the concepts you studied during 6th grade. If you need help to complete a problem the following websites are useful by searching the topic listed above the question.

<http://www.virtualnerd.com/middle-math/all>

<http://www.purplemath.com/modules/index.htm>

www.khanacademy.com

1. Summer Packets will be graded on completion and all work must be shown.
2. **This packet is due the day after Labor Day on September 4, 2018.**
3. The purpose of this assignment is to reinforce concepts taught in 6th grade and prepare students to expand and build on previous knowledge.
4. The grade is considered a Supportive Assignment. Advanced students will also have a quiz (Minor Assessment) based on content from the summer assignment.

Number Systems:

For #1 - 7, evaluate the following problems. SHOW ALL WORK! (No Calculator)

1) $20.5 + 82.9 =$

2) $\frac{1}{4} \div \frac{13}{7} =$

3) $\frac{2}{7} + \frac{11}{8} =$

4) $\frac{3}{7} \times \frac{3}{2} =$

5) $9.45 \div 0.7 =$

6) $0.56 \times 0.71 =$

7) $1,840 \div 80 =$

- 8) What is the greatest common factor (GCF) of 16 and 12?
- 9) Which of the following is equal to the expression $40 + 16$?
- A. $(8 \times 5)(8 \times 2)$
 - B. $8(5 + 2)$
 - C. $8 + (5 \times 2)$
 - D. $(8 + 5)(8 + 2)$
- 10) What is the least common multiple (LCM) of 10 and 12?

- 11) At what position on the number line is the point located?

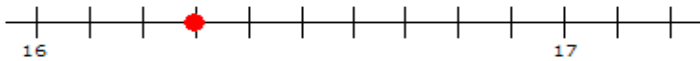

- 12) Which decimal below best represents an elevation of 2,000.24 feet below sea level?
- A. 2,000.24
 - B. 1,999.76
 - C. -2,000.24
 - D. -1,999.76

- 13) Which letter represents the opposite of -10 on the number line below?

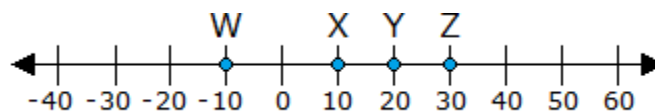

- A. Z
- B. X
- C. Y
- D. W

14) Which of the following is true given that $-\frac{2}{3} < \frac{3}{5}$?

- A. $-\frac{2}{3}$ is to the right of $\frac{3}{5}$ on a horizontal number line
- B. $-\frac{2}{3}$ is at the same place as $\frac{3}{5}$ on a horizontal number line
- C. $-\frac{2}{3}$ is the opposite of $\frac{3}{5}$ on a horizontal number line
- D. $-\frac{2}{3}$ is to the left of $\frac{3}{5}$ on a horizontal number line

15) What point located in quadrant III has an x-value that is 7 units from the origin and a y-value that is 2 units from the origin?

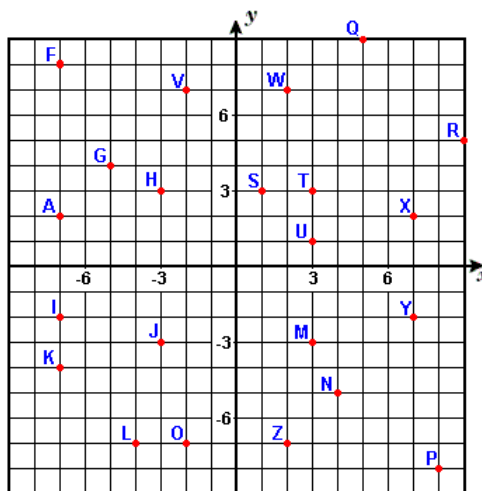

16) What are the coordinates of point P?

17) What is the distance between the points (10, 5) and (10, -13) in the coordinate plane?

18) What is the absolute value of a number?

19) Use the correct order of operations to solve the problem below.

$$13 - (4 + 2) - 9 \div 3$$

20) Simplify the following expression. $4.16 - 1.1 \times 2.6 + 0.7^2$

Ratios, Rates, Percent and Measurements:

21) Over time, Bailey has buried 6 large bones and 9 small bones in a hole. What is the ratio of small bones to large bones in the hole?

22) Curtis decided to go on a road trip to Canada. On the first day of his trip, he drove for 15 hours and traveled 870 miles. At what rate did he travel on the first day, in miles per hour?

23) The ratio of trumpet players to trombone players in the band is 5:3. What does this mean?

- A. There are 5 more trumpet players than trombone players.
- B. For every 5 trumpet players, there are 3 trombone players.
- C. There are 2 more trumpet players than trombone players.
- D. For every 5 trombone players, there are 3 trumpet players

24) Jody has 4 red marbles, 7 blue marbles, and 8 yellow marbles. What is the ratio of red marbles to blue marbles?

25) Convert 40 quarts to gallons.

26) Convert 9 feet to inches.

27) Which of the following is the missing value in the table?

- A. 4,500,000
- B. 4,000,000
- C. 4,900,000
- D. 3,500,000

Milligrams	Kilograms
?	4
5,000,000	5

28) Eighty-five percent of what number is 38.25?

29) What is 35% of 30?

Expressions and Equations:

30) Write an expression that represents the statement below?
seven minus the square of a number

31) Which algebraic expression is equivalent to the expression below?

$$7(3x + 8) - 3$$

- A. $21x + 56$
- B. $21x + 53$
- C. $21x + 5$
- D. $21x + 35$

32) Evaluate the expression below for $x = 6$.

$$\left(\frac{1}{6}\right)x^3 + 84$$

33) Which of the following describes $3a$ in the following expression: $4a^2 + 3a - 19$

- A. quotient
- B. term
- C. sum
- D. factor

In #34-39, solve each equation and check your solution.

34) $y + 54 = 80$ Check:

35) $52 = 4d$ Check:

36) $a - 45 = 91$ Check:

37) $20 = \frac{b}{2}$ Check:

38) $5.5u = 71.5$ Check:

39) $x + \frac{4}{9} = \frac{2}{3}$ Check:

40) Milo's Ice Cream Factory sold more than 41 waffle cones yesterday. Write an inequality represents the number of waffle cones Milo's Ice Cream Factory sold yesterday?

41) Which inequality is graphed on the number line?

- A. $x \geq 1$
- B. $x \leq 1$
- C. $x > 1$
- D. $x < 1$

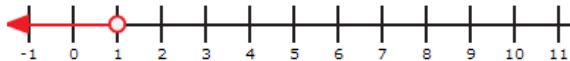

42) Each package of dog treats has 15 treats. The equation $d = 15t$, where d represents the total number of dog treats and t represents number of packages, shows this relationship. If Esther bought 60 dog treats total, how many packages did she buy?

- 43) Look at the relationship between a and b . Write an equation that describes the relationship between a and b ?

a	3	8	13	18
b	10	15	20	25

Geometry:

- 44) If $x = 9$ units and $h = 3$ units, then what is the area of the triangle shown?

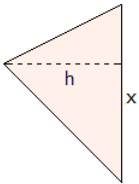

- 45) What is the area of the object?

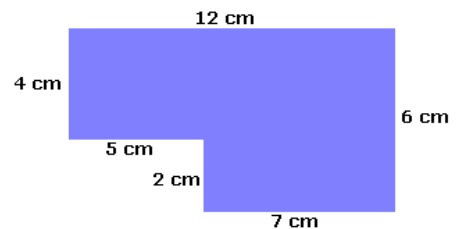

- 46) Samantha stores all of her important paperwork in the file cabinet shown below. What is the volume of the file cabinet?

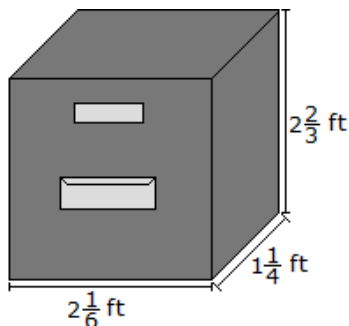

- 47) If $x = 8$ units, $y = 5$ units, and $h = 4$ units, then what is the area of the parallelogram shown above?

